

GU10  MITOS 913



**PL** Nie zawiera zestawu montażowego, dobór kołków/wkrętów we własnym zakresie

**ENG** installation kit not included, selection of dowels/screws on your own

**DE** Montagesatz nicht enthalten, Auswahl der Dübel/Schrauben auf eigene Faust

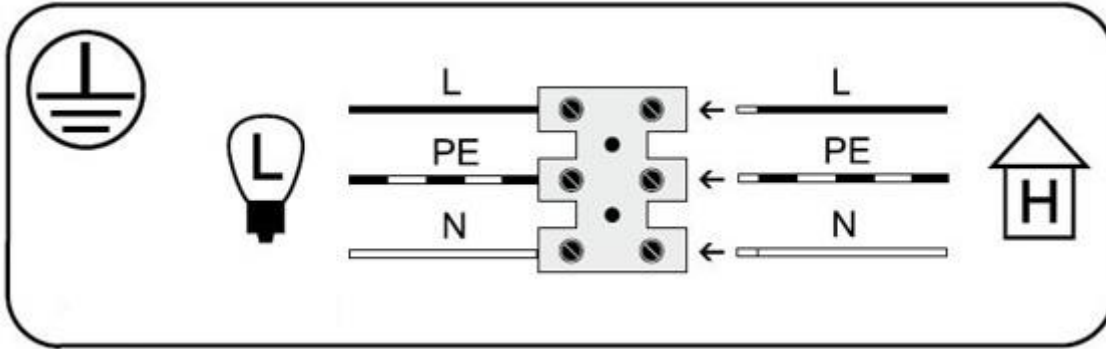

**ENG**

**L1**

Power wire (phase) brown



Protection class II Lamp without protective conductor

**L**

Power wire (phase) black



Protection class I Lamp with protective conductor. Protective conductor - symbol.

**PE**

Protective wire (yellow/green)



Symbol for mains connection on the lamp side

**N**

Neutral wire (blue)



Symbol for connection to the mains from the side of the house

**DE**

**L1**

Stromleitung (Phase) braun



Schutzklasse II Lampe ohne Schutzleitung

**L**

Stromleitung (Phase) schwarz



Schutzklasse I Lampe mit Schutzleitung

**PE**

Schutzleitung (gelb/grün)



Symbol für den Netzanschluss auf der Lampenseite

**N**

Neutraler Leiter (null)



Symbol für den Netzanschluss auf der Hausseite

**PL**

**L1**

Przewód prądowy (faza) brązowy



Klasa ochronna II Lampa bez przewodu ochronnego.

**L**

Przewód prądowy (faza) czarny



Klasa ochronna I Lampa z przewodem ochronnym. Przewód ochronny - symbol

**PE**

Przewód ochronny (żółto/zielony)



Symbol Podłączenie do sieci od strony lampy

**N**

Przewód zerowy (neutralny) niebieski



Symbol Podłączenie do sieci od strony domu