

argon® LAMPY

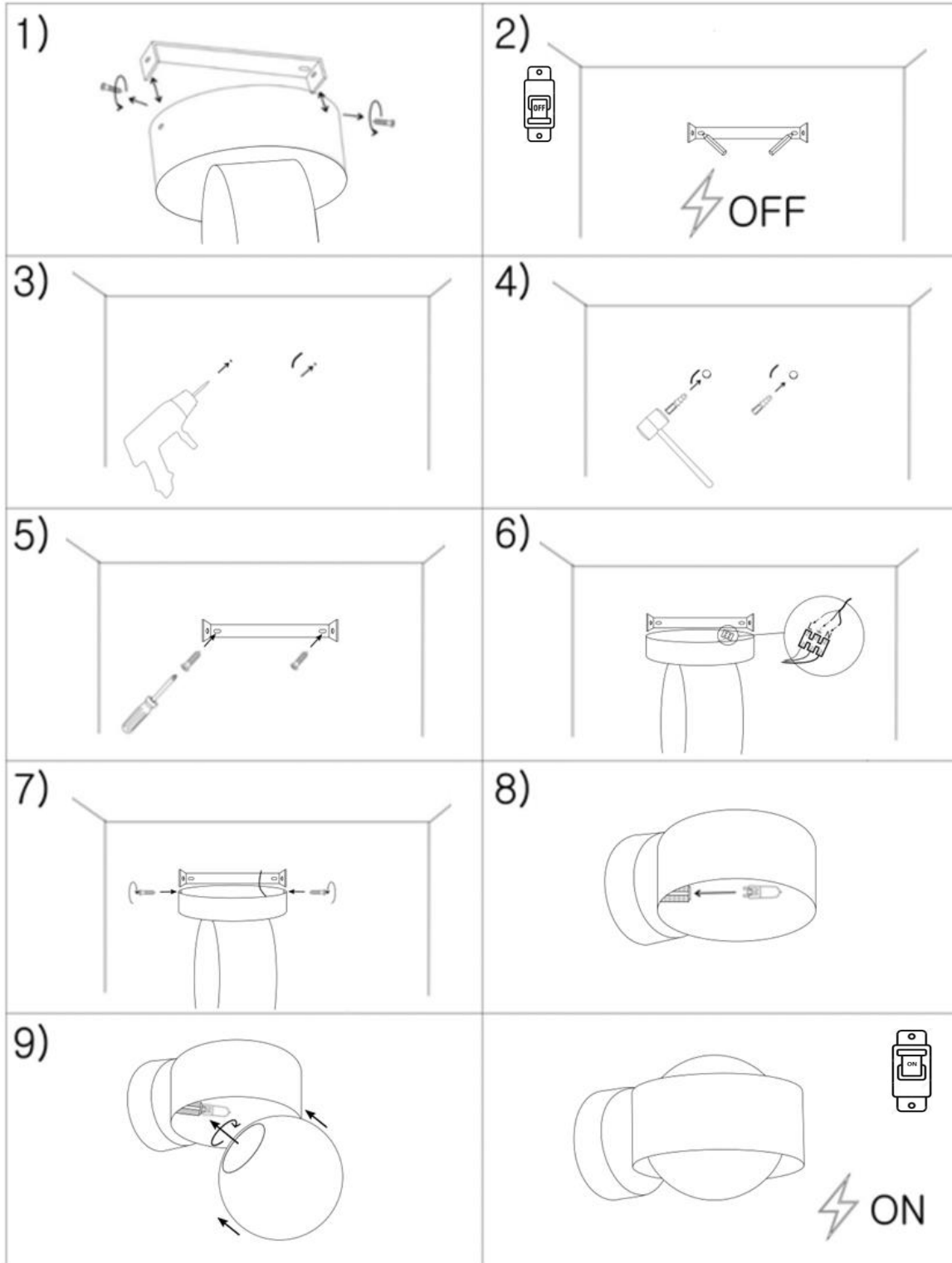

G9 LED MAX 6W  MASSIMO PLUS 8067

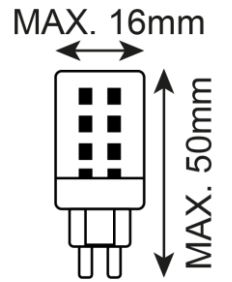
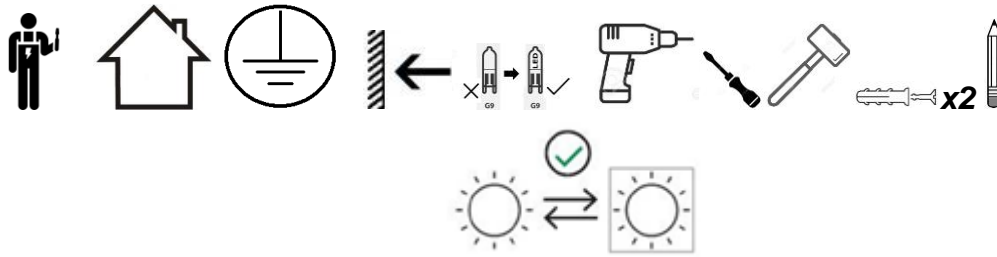
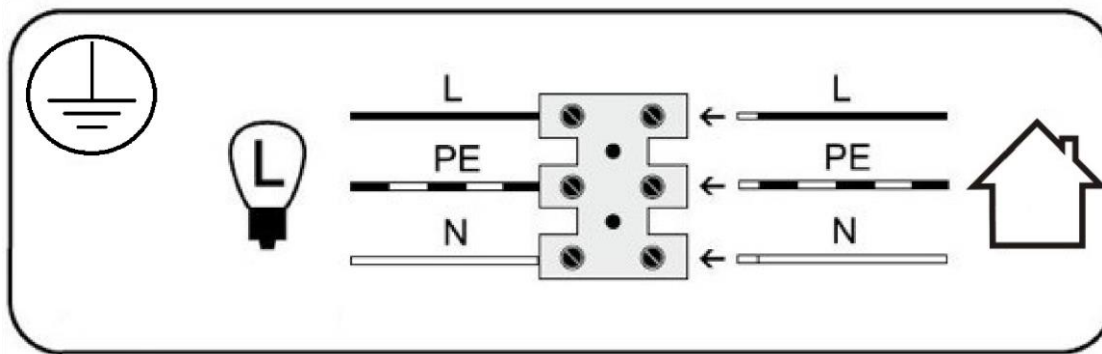

DE

L1

Stromleitung (Phase) braun



Schutzklasse II Lampe ohne Schutzleitung

L

Stromleitung (Phase) schwarz



Schutzklasse I Lampe mit Schutzleitung

PE

Schutzleitung (gelb/grün)



Symbol für den Netzanschluss auf der Lampenseite

N

Neutraler Leiter (null)



Symbol für den Netzanschluss auf der Hausseite

ENG

L1

Power wire (phase) brown



Protection class II Lamp without protective conductor

L

Power wire (phase) black



Protection class I Lamp with protective conductor. Protective conductor - symbol.

PE

Protective wire (yellow/green)



Symbol for mains connection on the lamp side

N

Neutral wire (blue)



Symbol for connection to the mains from the side of the house

PL

L1

Przewód prądowy (faza) brązowy



Klasa ochronna II Lampa bez przewodu ochronnego.

L

Przewód prądowy (faza) czarny



Klasa ochronna I Lampa z przewodem ochronnym. Przewód ochronny - symbol

PE

Przewód ochronny (żółto/zielony)



Symbol Podłączenie do sieci od strony lampy

N

Przewód zerowy (neutralny) niebieski



Symbol Podłączenie do sieci od strony domu